



LEICA Q3

QUICK START GUIDE



Download the full scope instruction manual here:

<https://en.leica-camera.com/Service-Support/Support/Downloads>

Please register via the following link if you would like to receive a printed copy of the full scope instruction manual:

<https://order-instructions.leica-camera.com>

PART DESIGNATIONS

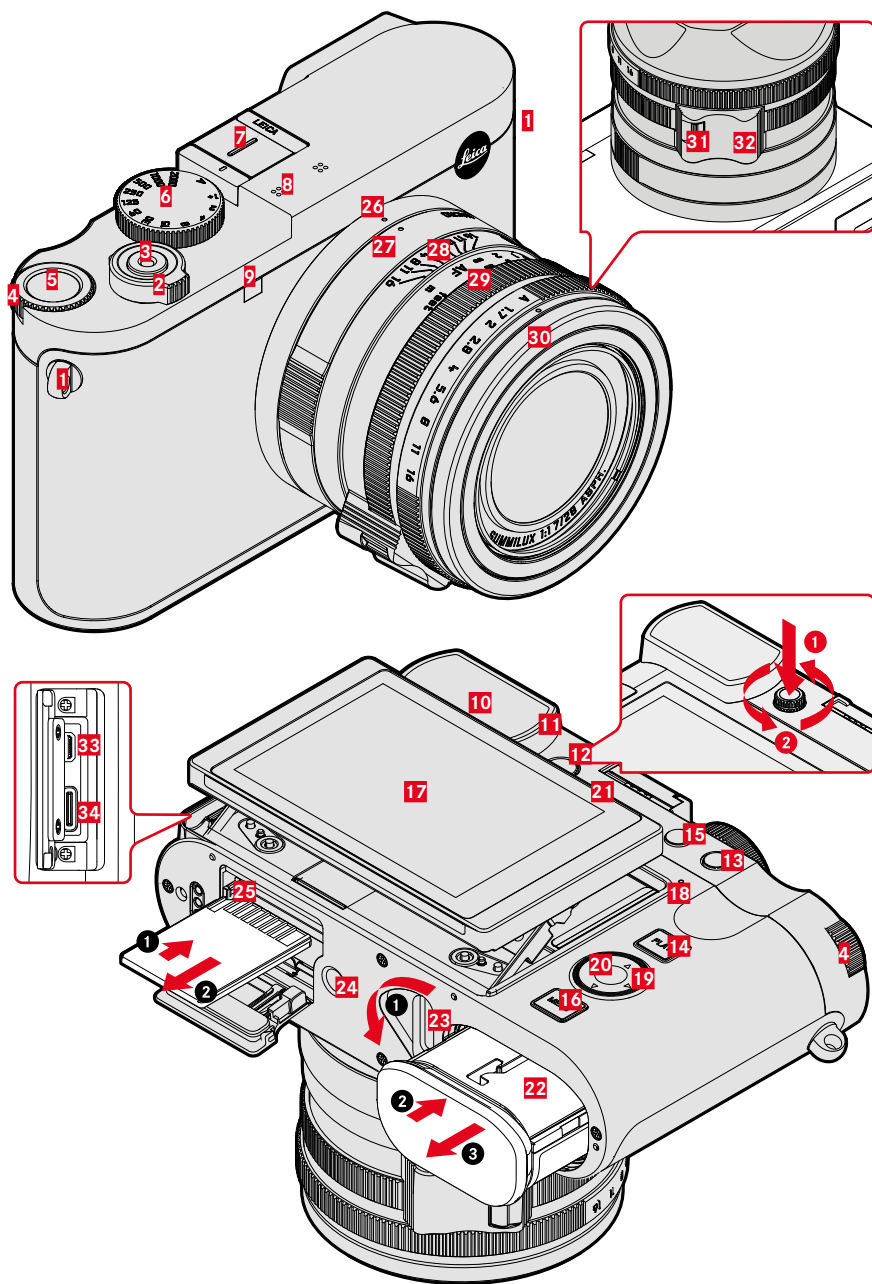

1 Strap lugs

2 Main switch

Switching the camera ON/OFF

3 Shutter button

tap:

- Autofocusing
- Activating exposure metering and exposure control

press down fully:

- Shutter release
- Video recording Start/Stop

in standby mode:

- The camera is reactivated

4 Thumbwheel

in the menu:

- Menu navigation

in shooting/recording mode:

- Depending on exposure mode

in review/playback mode:

- Zooming in/out

5 Thumbwheel button

in the menu:

- Applying menu settings

in shooting/recording mode:

- Direct access to menu functions

in review/playback mode:

- Factory setting: Magnification

6 Shutter-speed dial

- **A:** Automatic shutter speed control
- **2000 - 1+:** Fixed shutter speeds

7 Accessory shoe

8 Microphone

Sound is recorded in stereo

9 Self-timer LED/AF assist lamp

10 Viewfinder eyepiece

11 Eye sensor

12 Diopter wheel

Setting range: -4 dpt to +2 dpt

13 FN button

in shooting/recording mode:

- Direct access to menu functions

in review/playback mode:

- Factory setting: **Rate/Unrate**

14 PLAY button

Switchover between shooting/recording and review/playback mode

15 FN button

in shooting/recording mode:

- Direct access to menu functions

in review/playback mode:

- Factory setting: **Delete single**

16 MENU button

in the menu:

- Scrolling through the menu screens

in shooting/recording mode:







- Accessing the menu

in review/playback mode:

- Accessing the review/playback menu

17 LCD panel

3" TFT LCD, 1,843,200 dots, touch panel

Gesture	Operating mode	Function
	Shooting/Recording	Shifting the AF metering field
	Review/Playback	Selecting shots/recordings
	Menu	Selecting a menu item
	Shooting/Recording	Centering of the AF metering field
	Review/Playback	Zooming in/out
	Shooting/Recording	AF Quick Setting
	Shooting/Recording	Reducing the Live View display
	Review/Playback	Zooming out
	Shooting/Recording	Increasing the Live View display
	Review/Playback	Picture magnification
		Shooting/Recording
		Shooting/Recording/Review/Playback

18 Status LED

- Memory card access
- Using the WLAN function
- Firmware update in progress
- Charging process (wireless charging and charging via USB)

19 Directional pad

in the menu:

- Menu navigation
 - Applying menu settings
- in shooting/recording mode:
- Shifting the AF metering field

20 Center button

in the menu:

- Applying menu settings
- in shooting/recording mode:
- Direct access to menu functions
 - Factory setting: **Toggle Info Levels**
- in review/playback mode:
- Factory setting: **Toggle Info Levels**

21 Speaker

22 Battery compartment

23 Battery release lever

24 Tripod thread

A 1/4 DIN 4503 (1/4")

25 Memory card slot

26 Alignment point for macro function

27 Macro ring

28 Focus ring

29 Aperture ring

30 Thread protection ring

31 AF/MF lock release

32 Focus tab

33 HDMI port

34 USB-C port

The use of a 9 V/3 A (≥ 27 W) AC adapter is required where camera operation is desired while the battery is recharging.

Only the mains cables supplied must be used. The mains cables must only be used for the supplied charger unit. Do not attempt to use the mains cable or charger unit for other purposes.

PERMITTED CONNECTION TYPES

TETHERING PHOTO VIA USB-C

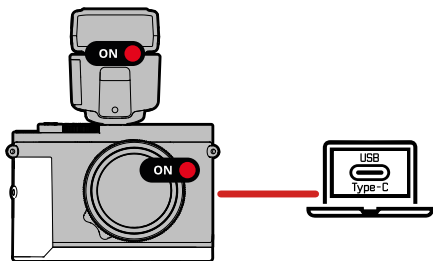

TETHERING VIDEO VIA USB-C + HDMI

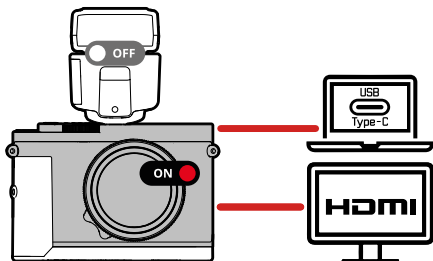

WIRELESS CHARGING

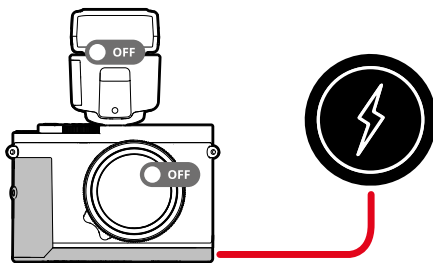

Note

- Use a switching adapter with a max. 100 W output or less, which complies with the USB-PD standard. Ensure compliance with the safety standards IEC62368-1 (ES1, PS2-compliant – 60 V or less, 100 W or less). Contact the manufacturer of the switching adapter if you are not sure that it complies with the safety standards.

SAFETY REMARKS

GENERAL INFORMATION

- Do not use your camera in the immediate vicinity of devices that generate powerful magnetic, electrostatic or electromagnetic fields (e.g. induction ovens, microwave ovens, television sets or computer screens, video game consoles, cell phones, broadcasting equipment). Their electromagnetic fields can interfere with image recordings.
- Strong magnetic fields, e.g. from speakers or large electric motors can damage the stored data or disrupt shooting.
- Switch off the camera, remove the battery briefly, replace it and switch the camera back on in case of a camera malfunction due to the effects of electromagnetic fields.
- Always store small parts e.g. the accessory shoe cover as follows:
 - out of the reach of children
 - in a safe location, where they will not get lost or stolen
- State-of-the-art electronic components are sensitive to static discharge. You can easily pick up charges of several 10,000 volts by simply walking on synthetic floor coverings. A static discharge can occur when you touch the camera and especially if it is placed on a conductive surface. A static discharge on the camera housing poses no risk for the electronics. Despite built-in safety circuits, you should avoid direct contact with external camera contacts like those in the flash shoe.
- Only use accessories specified for this model to prevent faults, short circuits or electric shock.
- Do not attempt to remove parts of the housing (covers) yourself. Repairs must be done at authorized service centers only.
- Prevent any sand or dust or water penetration into the camera, e.g. during snowfall or rain or on the beach. Be extra careful when changing the lens (in system cameras) and when inserting or removing the memory card and rechargeable battery. Sand and dust can damage the camera, the lens, the memory card and the battery. Moisture can cause malfunctions and irreparable damage to the camera and memory card.

LENS

- A camera lens can have the effect of a magnifying glass when exposed to direct frontal sunlight. The camera must therefore be protected against extended exposure to direct sunlight. Attaching the lens cap and keeping the camera in the shade or ideally in its camera case, will help prevent damage to the interior of the camera.

RECHARGEABLE BATTERY

- New batteries must be charged before initial use to be ready for activation in the camera. A full charge is recommended, as the batteries are delivered in an only partially charged state.
- Improper use of the batteries or the use of unapproved battery types may result in an explosion!
- Do not expose the rechargeable battery to sunlight, heat, humidity or moisture for prolonged periods of time. Likewise, the batteries must not be placed in a microwave oven or a high-pressure container as this would pose a fire or explosion hazard!
- Do not under any circumstances charge or insert a damp or wet battery into the camera!
- Keep the battery contacts clean and easily accessible. Although lithium-ion batteries are secured against short circuits, they should still be protected against contact with metal objects like paper clips or jewelry. A short-circuited battery can get very hot and cause severe burns.

- When a battery is accidentally dropped, make sure to check the housing and the contacts immediately for any damage. A damaged battery can damage the camera.
- The battery must be removed from the camera or charger and must be replaced immediately in case of a strange smell, discoloration, deformation, overheating or leakage. Continued use of the battery may result in overheating, which can cause fire and/or explosion!
- Never throw batteries into a fire as they may explode.
- Keep the battery away from sources of heat in case of leakage or if you smell burning. Leaked fluid can catch fire!
- The use of other chargers not approved by Leica Camera AG can cause damage to the batteries – and in extreme cases – cause serious or life-threatening injuries.
- Make sure that the power socket is freely accessible at all times.
- Do not attempt to open the battery or the charger. Repairs must only be carried out by authorized service centers.
- Keep batteries out of the reach of children. Batteries can cause suffocation when swallowed.

CHARGER

- Using the charger in the vicinity of broadcasting receivers may interfere with reception. Ensure a distance of at least 1 m between the charger and the receiver.
- When the charger is in use, it may emit a buzzing sound – that is normal and not a malfunction.
- Disconnect the charger from the mains when it is not in use, as it consumes electricity (a very small amount), even if no battery is inserted.
- Always keep the charger contacts clean, and never short-circuit them.

MEMORY CARD

- Never remove the memory card during a data save or card reading process. The camera must not be switched off or be subjected to impact or vibrations while working.
- Do not open the cover/remove the memory card or the battery from the camera while the status LED is lit, which indicates memory access. Data on the card may otherwise be destroyed and camera malfunctions may occur.
- Do not drop or bend memory cards as this will cause damage and result in the loss of stored data.
- Do not touch the connections on the reverse of the memory card and keep them clean and dry.
- Keep memory cards out of the reach of children. Swallowing a memory card may cause suffocation.

SENSOR

- Cosmic radiation (e.g. during flights) may cause pixel defects.

CARRY STRAP



- Once you have attached the carry strap, please make sure that the clips are mounted correctly to prevent the camera from falling.
- Carry straps are usually made of very robust material. You should therefore keep it out of the reach of children. A carry strap is not a toy and poses a strangulation risk.
- Use the carry strap only for its intended purpose on a camera or on binoculars. Any other use poses the risk of injury and may possibly result in damage to the carry strap and is therefore not permitted.
- Carry straps should also not be used for cameras/binoculars during sports activities that pose a risk of entanglement (e.g. when mountain climbing and similar outdoor activities).

REGULATORY INFORMATION

Specific regional approvals for this device can be found in the camera menu.

- ▶ Select **Camera Information** in the main menu
- ▶ Select **Regulatory information**

The icons displayed on this product (incl. the accessories) have the following meaning:

 Alternating current (AC)	 Class II devices (the product has a double-insulated design)
 Direct current (DC)	

DISPOSAL OF ELECTRICAL AND ELECTRONIC EQUIPMENT

(Applies within the EU and for other European countries with active waste separation policies.)



This device contains electrical and/or electronic components which must not be disposed of in general household waste. Instead, it should be disposed of at a recycling collection point provided by your local authority.

This service is free of charge. Any standard or rechargeable batteries used in this device must be removed and disposed of separately in accordance with local regulations.

Please contact your local authorities, waste disposal collection point or the retailer, from whom you purchased the device for more information on correct waste disposal.

CE MARK

The CE mark on our products documents compliance with the fundamental requirements of applicable EU guidelines.

English

Declaration of Conformity (DoC)

"Leica Camera AG" hereby declares that this product is in compliance with the basic requirements and other relevant provisions of Directive 2014/53/EU.

Customers can download a copy of the original DoC for our Radio Equipment products from our DoC server:

www.cert.leica-camera.com

Please contact Leica Camera AG, Am Leitz-Park 5, 35578 Wetzlar, Germany in case of any further questions

WARRANTY

In addition to your statutory warranty rights regarding your retailer, you will receive an additional Leica Camera AG product warranty valid from the date of purchase from an authorized Leica retailer. Previously, the product warranty was included in the packaging with the product. As a new service, the product warranty will from now on only be available online. You will be able to review the warranty conditions for your product at any time, without having to search for the document. Please note that this new policy applies only for products that are no longer delivered with a hardcopy product warranty included in the delivery. Any products still delivered with the warranty document remain governed exclusively by that document. For more information regarding the warranty scope, warranty services and limitations, please visit:

warranty.leica-camera.com

Leica Q3 comes with splash water and dust protection.

The camera was tested under controlled laboratory conditions and is classes as IP52 in accordance with DIN EN 60529.

Please note: The splash water and dust protection coating is not permanent and will diminish over time. The user manual contains instructions on how to clean and dry the camera. The warranty does not cover liquid damage. Any attempt to open the camera casing by an unauthorized retailer or service partner will cause an immediate expiration of the splash water and dust warranty.

TECHNICAL DATA

CAMERA

Designation

Leica Q3

Camera type

Digital 35 mm compact camera

Type No.

6506

Order No.

19 080 EU/US/CN, 19 081 JP, 19 082 ROW

Storage medium

UHS-II (recommended), UHS-I, SD/SDHC/SDXC memory card

Material

Full metal housing: magnesium die-cast, leather covering

Operating conditions

0°C to +40°C

Rated values for input voltage/power

7.2 V \approx 2.3 A (battery), 5 V \approx 2.3 A / 9 V \approx 2.5 A (USB)

Dimensions (WxHxD)

130 x 80 x 92.9 mm

Weight

Approx. 743 g/658 g (with/without battery)

SENSOR

Sensor size

CMOS sensor, 62.39 MP/60.3 MP (total/effective)

Image resolution

DNG™: 9520 x 6336 pixels (60.3 MP), 7404 x 4928 pixels (36.5 MP), 5288 x 3518 pixels (18.6 MP)

JPG: 9520 x 6336 pixels (60.3 MP), 7392 x 4928 pixels (36.4 MP), 5280 x 3512 pixels (18.5 MP)

LENS

Designation

Leica Summilux 28 f/1.7 ASPH., 11 lenses in 9 segments, 3 aspherical lens areas

Lens filter thread

E49

VIEWFINDER/LCD PANEL

Viewfinder (EVF)

Resolution: 5,760,000 dots, 120 fps, magnification: 0.79x at aspect ratio: 4:3 / 0.76x at aspect ratio: 3:2, frame coverage: 100%, exit pupil position: 20.75 mm, setting range -4/+2 dpt, with eye sensor for automatic switchover between viewfinder and LCD panel, time delay 0.005 s

LCD panel

3" TFT LCD, 1,843,200 dots, touch control available

EQUIPMENT

WLAN

The Leica FOTOS app is required to use the WLAN function. The Leica app is available from the Apple App Store™ or the Google Play Store™.

	2.4 GHz	5 GHz	
EU/ US/ CN	IEEE802.11b/g/n; Channel 1-11 (2412-2462 MHz)	Client mode: (For indoor use only) IEEE802.11a/n/ac: Channel 36-64 (5180-5320 MHz)	Access point + client mode: IEEE802.11a/n/ac: Channel 149-165 (5745-5825 MHz)
JP		Access point + client mode: (For indoor use only) IEEE802.11a/n/ac: Channel 36-48 (5180-5240 MHz)	Client mode: (For indoor use only) IEEE802.11a/n/ac: Channel 52-144 (5260-5720 MHz)
ROW			-

Maximum output (e.i.r.p.): <14 dBm, encryption method: WLAN-compatible WPA™/WPA2™/WPA3™

Bluetooth

Bluetooth 5.0 LE: Channel 0-39 (2402-2480 MHz), maximum output (e.i.r.p.): 10 dBm

POWER SUPPLY

Rechargeable battery (Leica BP-SCL6)

Lithium-ion rechargeable battery, rated voltage: 7.2 V (DC); capacity: 2200 mAh (min.), 350 shots (based on CIPA standard, with **All Displays Auto Off = 5 s**); manufacturer: Panasonic Energy (Wuxi) Co. Ltd., Made in China

Charger (Leica BC-SCL4)

Input: AC 100-240 V, 50/60 Hz, 0.25 A, automatic switchover; output: DC 8.4 V 0.85 A; manufacturer: Salom Electric (Xiamen) Co., Ltd., Made in China